

CM

Costambar Monthly

**June
2026
FREE**



ESTABLISHED 2002

HAPPENINGS

Los Tres Cocos in Las Rocas invites you to try something different. Call 809-993-4503 for more information. Also, check out their Facebook page. **Closed for holidays from June 10 to July 14**

Big Lee's Beach Bar on the Malecon is daily from 10am to 8pm. Plenty of time to enjoy their burgers, chicken breast strips, hot dogs and fish & chips! The only 5-star restaurant on the Malecon!

The **Seaside Cafe** on the Malecon has Good Food, Good Coffee and Good Vibes! Open Monday to Friday 7am to 3pm.

DATES TO REMEMBER



June 4 - Corpus Cristi (DR)

June 21 - Father's Day (Can & US)

FIND A COPY OF CM AT

COSTAMBAR

Jenny's Market

PUERTO PLATA

Big Lee's Beach Bar

Tropico Dental Clinic

LAS ROCAS

Los Tres Cocos

COFRESI

Ocean World Marina

JUNE 29

The "Strawberry Moon" name has been used by Native American Algonquian tribes that live in the northeastern United States as well as the Ojibwe, Dakota, and Lakota peoples to mark the ripening of "June-bearing" strawberries that are ready to be gathered.



CRUISE SHIP SCHEDULE

You can find the full monthly schedule for both ports at the following website: <https://www.cruisemapper.com/ports/puerto-plata-amber-cove-port-1936?tab=schedule>



LIFE IS BETTER IN
flip flops

Costambar
WIBES



BIG LEE'S Beach Bar

Open Daily at 10am - 8pm

**OPEN 15 YEARS!!
ALWAYS RATED 5-STARS
FOR FOOD, SERVICE,
HOSPITALITY &
LOW PRICES!**

**COME ON DOWN TO THE
MALECON & ENJOY A
BEAUTIFUL AFTERNOON!**



We speak English, German and Spanish
and have our own dental laboratory.

WhatsApp and local Phone number: 809 586 9245

We are right behind the fire station on the Malecon beside the park.
Opposite to the Centro Sanitario. You can find us also on Google Maps.

Street name: Emilio Prud Homme, esq. Sanchez Puerto Plata
We cater for all your dental needs.

**SOMETIMES YOU MEET
SOMEONE AND YOU
KNOW FROM THE
FIRST MOMENT THAT
YOU WANT TO SPEND
YOUR WHOLE LIFE
WITHOUT THEM.**

**IF YOU USED ONE OF THESE
BACK IN THE DAY**

**CHANCES ARE YOU'RE
IMMUNE TO EVERYTHING**

I just learned the professional way to say "I told you so":

"This was identified early on as a likely outcome."

**SUPPORT OUR ADVERTISERS!
THEY MAKE
COSTAMBAR MONTHLY
POSSIBLE!**

Los Tres Cocos
RESTAURANT
INTERNATIONAL GOURMET
CUISINE
&
AUSTRIAN SPECIALTIES

**Closed for holiday from
June 10 to July 14**

Tel. (809) 970-7627
Cel. (809) 993-4503
Las Rocas Cofresi,
Martes Cerrado



**Always make sure
SOMEONE in the
relationship has
good credit. That's
why it's called
SIGNIFICANT other.
Sign/if/I/can't.
Follow me for more
marriage tips**



Once you hit a certain age life just becomes a delicate balance between trying to stay awake and trying to fall asleep while slowly getting worse at both

- How to tell you're an adult:**
- You gain 30lbs overnight
 - You'd rather sleep than go out
 - Everything hurts
 - Comfort comes before style
 - You have a favorite spatula
 - Everything feels like a chore
 - College students look like 12yr olds
 - You're always annoyed

**SPONSORS
WANTED**

FOR OUR
**2027
★ PLAY ★**

*A Map,
A Compass
& No Idea*



**COSTAMBAR
PLAYERS**

WhatsApp 809 445 2059
Email michaelkingdon9@hotmail.com

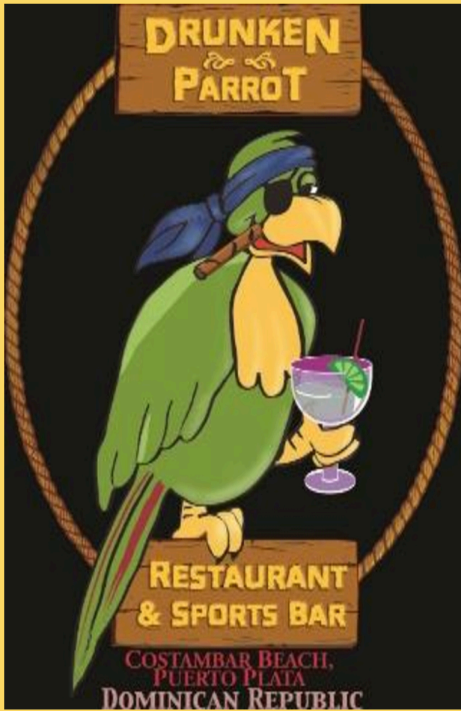

Located at Blackbeards Resort
 Costambar, Puerto Plata
 Open from 8am – 11pm

The Drunken Parrot Restaurant & Bar
 Invites You to Join Us
 Every Sunday for Our Spectacular
 All You Can Eat BBQ from 1pm till 3pm
 Ribs, Hamburgers, Wings, Macaroni and Tuna Salad,
 Corn on the Cob, Potato Wedges, Cole Slaw
 Cucumber & Tomato Salad and Flan for Dessert
 Free Drinks include Coke, Water, Rum Punch
 & Cuba Libres. Other beverages are available to buy.

\$RD1,200 Per Person

plus 18% Gov't tax and 10% service charge

to View Our Complete Menu Go to
www.blackbeardsadultresort.com

Click on Facilities and Scroll Down and Click Menus



Item	Price	Item	Price
OMELETTE	RD\$390	CUP CAKE	RD\$150
CROISSANT	RD\$165	NATURAL JUICES	RD\$225
SANDWICH	RD\$360	SMOOTHIE	RD\$150
SANDWICH DE PIERNA	RD\$390	AMERICANO COFFEE	RD\$50
YAROA	RD\$450	COFFEE WITH MILK	RD\$100
		AMERICANO COFFEE	RD\$50
		DOMINICAN COFFEE	RD\$50
		CHOCOLATE	RD\$50
		CHOCOLATE WITH MILK	RD\$100

WELCOME!
 Thank you for choosing us. We appreciate your visit and hope you enjoy your time by the sea.
 Gracias por preferirnos!

My Mom was cleaning out their liquor cabinet and offered me a bottle of Vodka they've had for ages.

I had to say no because I know it's 70% water from me stealing it when I was 16.

ME: 'Hello. Is this the helpline for alcoholics?'

'Yes, it is'

ME: 'How do I make a Mojito?'

DON'T WATCH WHAT THEY WANT YOU TO WATCH ON YOUR TV. WATCH WHAT YOU WANT TO WATCH. NO CABLES JUST WIFI

Thousands of TV channels & movies available to watch any time you want. Watch all the most popular TV series and movies as well as live sports & documentaries. Available worldwide for most devices. All available for less than 10 pesos a day, with help setting up and local assistance. Works with most devices as well as smart TV's.

Whatsapp me for more details

Colin 809-449-1819

They say when you snooze, you lose. I say, when you take a nappy, you're happy.

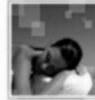

Ton Plokkaar

The best massage in town!

PROFESSIONAL MASSAGE

- Therapeutic Massage
- Sport Massage
- Deep Tissue Massage Trigger
- Point Massage Lymph
- Massage/Drainage
- Relaxation Massage
- Laser Therapy
- Pain Management

Home And Hotel Visits

Tel: **829 549 9516**

Email: plokkie@hotmail.com



WhatsApp

Ton Plokkaar is certified and member of VOMAS: No. 12721007



Last year I replaced all the windows in my house with those expensive, double-pane, energy-efficient kind. Today, I got a call from Home Depot who installed them. The man complained that the work had been completed a year ago, and I still hadn't paid for them.

HHHelloo.....just because I'm blonde doesn't mean that I am automatically stupid. So, I told him just what his fast-talking sales guy had told me last year... that these windows would pay for themselves in a year.

Hellooooo, it's been a year, so they're paid for, I told him. There was only silence at the other end of the line, so I finally hung up. He never called back. I bet he felt like an idiot!!!

THE RAINY DAY PAGE

SOLUTIONS ON PAGE 9

SUDOKU PUZZLES

Fill in the missing numbers so every row, column and quadrant contains the number 1 through 9.

EASY

				4	8		6
2							1
4		1	7	8			3
3			8	1			5
				6	5	7	9
	5						6
	3		6	1	7		
		2					

MEDIUM

	3					9		
2	1							
4			3					6
		4	6					8
		7		5		2		
	9							
	4				7	5	9	
					2			
5			1	4				

FANTASY WORLD

Find and circle all of the words that are hidden in the grid. The remaining letters spell a hidden message

F T H G O L D H T E R G O E E
 O R C L D C E O O E L S R P S
 R U T E R U W R L P D T E D R
 E A I O C E N D T R O A T D O
 S T W W R I D G A S S I A A H
 T N A O I E L U E A N G S E B
 E E R B P N G A N O G I R O O
 W C L S F T E T H E N O M H N
 E P O S F A R M R C I G A M Q
 L R C O E G D I R B W A R D U
 T I K R L A N C E T I R P S E
 S N E C G N O M E S P E A R S
 A C E L A G I A N T S M O A T
 C E M A C E S E R V A N T R I
 N S N O P A E W G S S E V L E

- | | | | |
|------------|--------|----------|---------|
| ALE | ELVES | LANCE | QUEST |
| BATTLE | FARM | MACE | SERVANT |
| CASTLE | FOREST | MAGIC | SPEARS |
| CENTAUR | GIANTS | MINSTREL | SPRITE |
| CHALICE | GNOMES | MOAT | STEW |
| CROSSBOW | GOLD | OGRE | TOWER |
| CROWN | GUARDS | PEASANT | WARLOCK |
| DAGGER | HERO | PEDDLER | WEAPONS |
| DRAWBRIDGE | HORSE | POISON | WINE |
| DUNGEON | INN | PRINCE | WITCH |

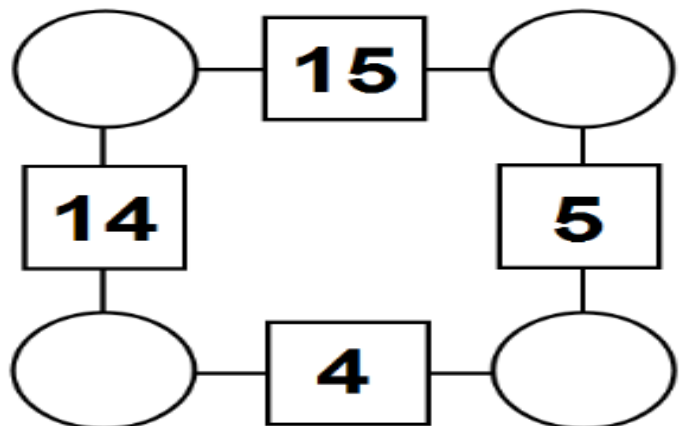

The aim of an arithmagon is to work out which numbers go in the empty circles. The numbers in the square boxes are made by adding together the numbers in the circles either side. For example, if the number in the square box was 10 you could try 6 and 4, but the numbers must also add up on the other edges, making this more difficult than it first appears.

 USEFUL NUMBERS	
Police Office	809-320-8510
Police Car	809-320-8840
APC Office	809-970-7877
APC Gate Security	809-970-7015
Codetel	809-220-1111
Edenorte - emergency	809-261-1844
Edenorte - office	809-586-9823
Costambar Taxi Stand	809-970-7318
CONSULATES	
Canada	809-586-5761
Britain	809-586-4244
U.S.A.	809-586-4204
German	809-542-8949
Italian	809-320-7601
HOSPITALS/CLINICS	
Clinica Bournigal	809-586-2342
Clinica Brugal	809-586-2519
Los Tropicos Pharmacy	809-970-7607

TRAVEL INFO

OVERSTAY FEES

Calculation for Stay Payment

Duration of stay	Current rate
30 días a 90 días	RD\$ 3,500.00
3 a 9 meses	RD\$ 5,600.00
9 a 12 meses	RD\$ 7,000.00
12 a 18 meses	RD\$9,100.00
18 a 24 meses	RD\$ 11,200.00
24 a 30 meses	RD\$ 13,300.00
30 a 36 meses	RD\$ 15,400.00
36 a 48 meses	RD\$ 22,400.00
48 a 60 meses	RD\$ 28,000.00
6 años	RD\$ 42,000.00
7 años	RD\$ 56,000.00
8 años	RD\$ 70,000.00
9 años	RD\$ 84,000.00
10 años	RD\$ 98,000.00

Note: From ten (10) years, each year or fraction, will increase RD \$ 7,000.00. This payment is not an extension that authorizes the foreigner to remain in the country

Digital Entry & Departure Forms

<https://eticket.migracion.gob.do/>

The people who make fitted sheets need to sit down with the people who make mattresses and get on the same page.

Making the bed shouldn't be like putting a swimming cap over a fridge.

Life's short. Make sure you spend as much time as possible on the Internet arguing with strangers about politics.

COSTAMBAR MONTHLY

RATE CARD
NOVEMBER 2015

SIZE	APPROX. SIZE	PRICE/MONTH
FULL PAGE – BACK	8"X10"	RD\$4200
FULL PAGE – INTERIOR	8"X10"	RD\$3700
1/2 PAGE	8"X5" OR 4"X10"	RD\$2100
1/4 PAGE	4"X5"	RD\$1150
1/8 PAGE	4"X2.5"	RD\$650
BUSINESS CARD AD	4"X2"	RD\$520
CUSTOM SIZE/SHAPE ADS		Contact Us for a Quote

CONTACT US AT:

WEBSITE www.costambarmonthly.com

EMAIL costambarmonthly@gmail.com

PHONE 809-970-7507

I am often mistaken for an adult because of my age.

Jenny's Supermarket

OPEN DAILY (INCLUDING HOLIDAYS)
 Mon-Sat 8am-10pm Sundays 8am-8pm
 Everything you need from snacks to supper!
 Delivery Service Available!
 Calle Principal, Costambar (just inside the gate)
 809-970-3028

www.costambarmonthly.com

TOM CIGARS

QUALITY CIGARS AT FAIR PRICES

829-925-2989/829-721-9435
 Thomasaikins644@gmail.com
 16 de agosto, esq. 12 de Julio, Puerto Plata



To be called inconsistent, you
 have to be consistently inconsistent.
 Making you consistent.

SOLUTIONS TO PUZZLES ON PAGE 7

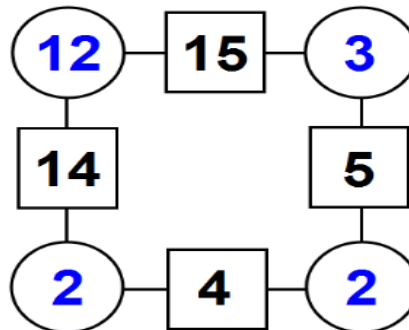
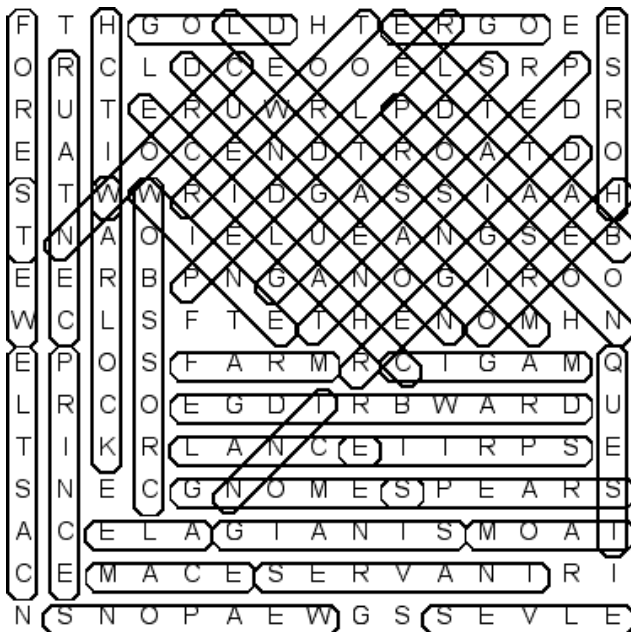

EASY

7	9	3	1	2	4	8	5	6
2	8	5	9	3	6	4	7	1
4	6	1	7	5	8	9	3	2
3	7	6	8	9	1	2	4	5
5	1	9	4	7	2	6	8	3
8	2	4	3	6	5	7	1	9
1	5	7	2	4	9	3	6	8
9	3	8	6	1	7	5	2	4
6	4	2	5	8	3	1	9	7

MEDIUM

7	3	6	2	8	5	9	1	4
2	1	8	9	4	6	3	5	7
4	5	9	3	7	1	8	6	2
3	2	4	6	1	9	7	8	5
1	6	7	4	5	8	2	3	9
8	9	5	7	2	3	1	4	6
6	4	2	8	3	7	5	9	1
9	8	1	5	6	2	4	7	3
5	7	3	1	9	4	6	2	8

HIDDEN MESSAGE THE LORD OF THE RINGS



FOR RENT

STUDIO APT

AVAILABLE STARTING APRIL THRU DECEMBER.
3RD FLOOR, CATHEDRAL CEILINGS, FURNISHED
AIR, WIFI, PRIVATE ENTRANCE
OCEAN VIEW - 2 BLOCKS FROM THE BEACH
\$400/ MONTH + ELECTRIC, 1ST MONTH + SECURITY DEPOSIT

2 BEDROOM 2 BATH

3RD FLOOR, CATHEDRAL CEILINGS, FURNISHED
ROOF TOP GARDEN, OCEAN VIEWS / MOUNTAIN VIEWS
AIR, WIFI, 2 BLOCKS FROM BEACH
\$800 MONTH + ELECTRIC, 1ST MONTH + SECURITY DEPOSIT

WhatsApp 809-266-7122 / mjpd345@gmail.com

FOR SALE LOASE RETREAT RESORT

10-room Boutique Resort in Gated Costambar
Fully Operational
Low-pressure Vibe
Strong Repeat Guests
5 min Walk to Costambar Beach
30 min from POP airport

WHAT'S INCLUDED:

- 10 guest rooms with hot water, lock boxes, cable TV
- Indoor court for racquetball, pickleball, squash, volleyball
- Pool, rooftop lounge, tiki lounge
- On-site Sam's Bar & Restaurant
- 1 block from Golf Clubhouse
- 4.5★ on Tripadvisor, ranked #4 of 12 resorts in Puerto Plata

IDEAL BUYER:

Owner-operators, hospitality groups, religious & nonprofit groups, medical teams like Doctors Without Borders running retreats or volunteer bases.

CONTACT:

Joseph Kruchten
WhatsApp: +1 809 837 6845
Email: loaseretreat4@gmail.com
Brokers welcome.



www.costambarmonthly.com

costambarmonthly@gmail.com

INSURANCE

Health Insurance Plans
Available for terms as short as 3 months
Available up to 65 years of age
No medical required

Call/WhatsApp
Colin 809-449-1819 or
Email drcigarman@yahoo.com
For more information

SOLAR PANELS FOR YOUR HOME

The Way To Go
550 watt panels
Now available in Costambar

You don't need to spend a lot to make your life in paradise more pleasant during power cuts

Whatsapp Colin
809-449-1819

BOATING NEEDS

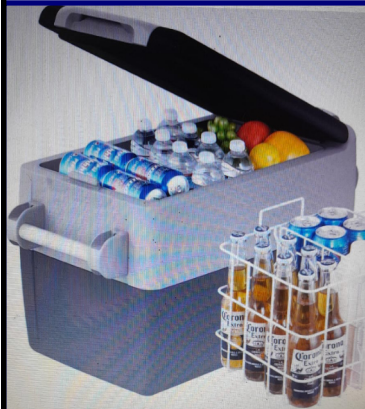

**BOAT/CAR
FRIDGE/
FREEZER**
- 12/24V DC
- 110V AC
ADAPTER
- LARGE
CAPACITY

**DUAL COMPARTMENT
ANTI-SHAKE DESIGN
CAN TILT 40 DEGREES
BUILT IN LED LIGHT
LOW ENERGY CONSUMPTION
ENERGY SAVING MODE
LOW BATTERY PROTECTION
AUTO-STOP WHEN LOW
BATTERY**

**ONLY 2 LEFT!
US\$320**

NOW IN STOCK



Solar lights
ideal for
mounting on
Outboard engine,
boat decks etc
"Be seen!".

**FOR MORE DETAILS
AND TO PLACE AN
ORDER**

BOATER'S SPECIAL

*Health Insurance Plans
Available for terms as short as 3 months
Available up to the age of 65*

Call/WhatsApp Alison 829-805-5196

Or Colin 809-449-1819 or

Email drcigarman@yahoo.com

For more information

SOLAR PANELS IN STOCK

BATTERIES

- Lithium
- Deep cycle AGM 12v
- Trojan 6v red and black
- Starter batteries



6v 210ah AGM

RD\$11,750

Delivered To Luperon & Ocean World

Call/Whatsapp

Alison 829-805-5196

Colin 809-449-1819

Email drcigarman@yahoo.com



Sea Horse Condos Ocean View Condominiums

**ONCE YOU'VE SEEN THE REST
STAY AT THE BEST
BEST CONDOS IN THE BEST
COMPLEX IN COSTAMBAR FOR SALE
FOR SALE 1 TO 3 BEDROOM**

- Condo #1 3 Bdrm mtn view \$139,000**
- Condo #2 2 Bdrm ocean view \$149,000**
- Condo #4 3 Bdrm ocean view \$159,000**
- Condo #6 3 Bdrm ocean view \$169,000**
- Condo #8 1 Bedroom \$109,000**
- Condo #9 2 Bedroom \$129,000**

**RENTALS COMING JUNE 1st
\$500-\$1000 Studio to 3 bedroom**

**POOL-JACUZZI-GYM-BILLIARDS
POWER PLANT-24HR SECURITY
OFF STREET PARKING
OCEAN VIEWS AND BREEZES**

jackflor@aol.com

Call 809-693-3059/Whatsapp 218-348 -3050