

# CM

**Costambar Monthly**

**May  
2026  
FREE**



**ESTABLISHED 2002**

# HAPPENINGS

**Los Tres Cocos** in Las Rocas invites you to try something different. Call 809-993-4503 for more information. Also, check out their Facebook page.

**Big Lee's Beach Bar** on the Malecon is daily from 10am to 8pm. Plenty of time to enjoy their burgers, chicken breast strips, hot dogs and fish & chips! The only 5-star restaurant on the Malecon!

## DATES TO REMEMBER

**May 4** - Labour Day (DR)

**May 10** - Mother's Day (Can & US)

**May 18** - Victoria Day (Can)



## CRUISE SHIP SCHEDULE

You can find the full monthly schedule for both ports at the following website: <https://www.cruisemapper.com/ports/puerto-plata-amber-cove-port-1936?tab=schedule>

## FIND A COPY OF CM AT

**COSTAMBAR**

Jenny's Market

**PUERTO PLATA**

Big Lee's Beach Bar

Tropico Dental Clinic

**LAS ROCAS**

Los Tres Cocos

**COFRESI**

Ocean World Marina

**MAY 1 & 31**

May's Flower Moon name should be no surprise; flowers spring forth across North America in abundance this month! In May, a second Full Moon, a Blue Moon, will make an appearance. The term Blue Moon is most commonly used when we have two Full Moons in a single month.

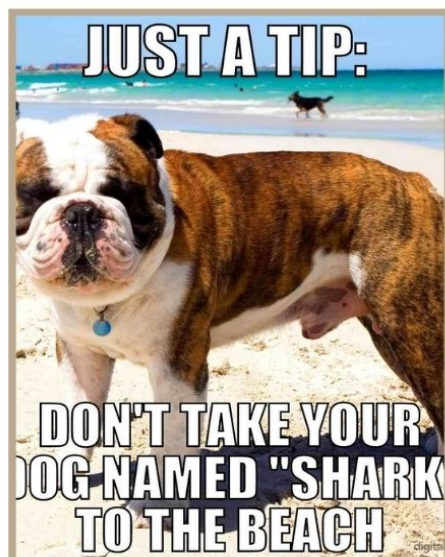

My mind is exceptionally quiet today. I'm suspicious. I'm up to something I don't want me to know about.



@We Are Nature



We speak English, German and Spanish and have our own dental laboratory.

WhatsApp and local Phone number: 809 586 9245

We are right behind the fire station on the Malecon beside the park. Opposite to the Centro Sanitario. You can find us also on Google Maps. Street name: Emilio Prud Homme, esq. Sanchez Puerto Plata We cater for all your dental needs.

Why do you want this job is such a dumb question.

@corporate.snark

Do you really think I want to punch numbers into excel all day and send stupid little emails? No I'd rather be traveling the world, but I need money. Get a grip.

# BIG LEE'S Beach Bar

Open Daily at 10am - 9pm



Meta AI

Big Lee's Beach Bar is located in Puerto Plata, Dominican Republic, specifically on the Malecon, also known as Ave. General G. Luperon, along the oceanfront. It's situated between two islands, with one island featuring a statue of Neptune, and is easily accessible by taxi. The bar is on the beach side of the Malecon, in a building with multiple cassetas, and is the left-hand side business. Big Lee's Beach Bar is a popular spot, ranked #1 of the top 100 places to eat lunch in Puerto Plata and #1 of the bars and pubs in the area <sup>1</sup>.

LAST NIGHT I GOT THROWN OUT OF THE CASINO



I TOTALLY MISUNDERSTOOD THE CRAPS TABLE

**SUPPORT OUR ADVERTISERS!  
THEY MAKE  
COSTAMBAR MONTHLY  
POSSIBLE!**

**Los Tres Cocos**  
RESTAURANT  
**INTERNATIONAL GOURMET  
CUISINE  
&  
AUSTRIAN SPECIALTIES**

Tel. (809) 970-7627  
Cel. (809) 993-4503  
Las Rocas Cofresi,  
Martes Cerrado

An old Doberman starts chasing rabbits and before long, discovers that he's lost.

Wandering about, he notices a lion heading rapidly in his direction with the intention of having lunch.

The old Doberman thinks, "Oh, oh! I'm in deep shit now!"

Noticing some bones on the ground close by, he immediately settles down to chew on the bones with his back to the approaching cat.

Just as the lion is about to leap, the old Doberman exclaims loudly,

"Boy, that was one delicious lion! I wonder, if there are any more around here?"

Hearing this, the young lion halts his attack in mid-stride, a look of terror comes over him and he slinks away into the trees.

"Whew!," says the lion, "That was close! That old Doberman nearly had me!"

Meanwhile, a squirrel who had been watching the whole scene from a nearby tree, figures he can put this knowledge to good use and trade it for protection from the lion. So, off he goes.

The squirrel soon catches up with the lion, spills the beans and strikes a deal for himself with the lion.

The young lion is furious at being made a fool of and says, "Here, squirrel, hop on my back and see what's going to happen to that conniving canine!"

Now, the old Doberman sees the lion coming with the squirrel on his back and thinks, "What am I going to do now?," but instead of running, the dog sits down with his back to his attackers, pretending he hasn't seen them yet, and just when they get close enough to hear, the old Doberman says.....

"Where's that squirrel? I sent him off an hour ago to bring me another lion!"

Moral of this story...

Don't mess with the old dogs... Age and skill will always overcome youth and treachery!

Bull Shit and brilliance only come with age and experience.

In America, the phrase "work-life balance" refers to how fast you can eat a burger while crying in your car

**His mom cuts his hair**



**Don't tell anyone 'I hate you'.  
Say 'You are the Monday of my life'.**

**How do hard shell tacos survive factories, delivery trucks, and store shelves, but crumble the second you put something inside them?!**

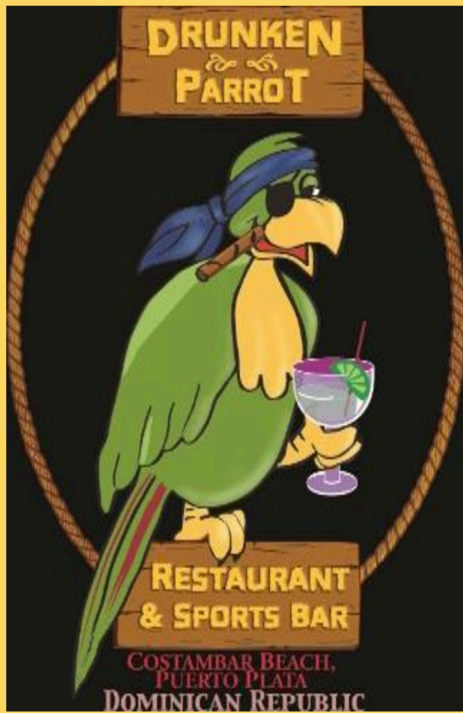

Located at Blackbeards Resort  
 Costambar, Puerto Plata  
 Open from 8am – 11pm

The Drunken Parrot Restaurant & Bar  
 Invites You to Join Us  
 Every Sunday for Our Spectacular  
 All You Can Eat BBQ from 1pm till 3pm  
 Ribs, Hamburgers, Wings, Macaroni and Tuna Salad,  
 Corn on the Cob, Potato Wedges, Cole Slaw  
 Cucumber & Tomato Salad and Flan for Dessert  
 Free Drinks include Coke, Water, Rum Punch  
 & Cuba Libres. Other beverages are available to buy.

\$RD1,200 Per Person  
 plus 18% Gov't tax and 10% service charge

to View Our Complete Menu Go to  
[www.blackbeardsadultresort.com](http://www.blackbeardsadultresort.com)

Click on Facilities and Scroll Down and Click Menus

[costambarmonthly@gmail.com](mailto:costambarmonthly@gmail.com)

When you accidentally close the one  
 tab you actually needed out of 87.

If dogs had romance novels...  
 he'd be on the cover.

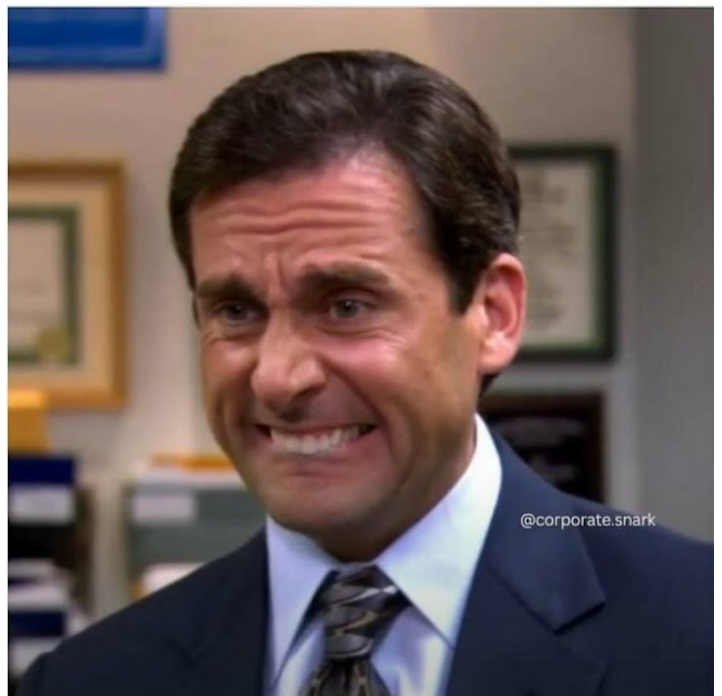

[www.costambarmonthly.com](http://www.costambarmonthly.com)

**BUTTER IS SUCH A SUPERFOOD THAT IT HAS ITS OWN PENTHOUSE IN THE FRIDGE**



**DON'T WATCH WHAT THEY WANT YOU TO WATCH ON YOUR TV. WATCH WHAT YOU WANT TO WATCH. NO CABLES JUST WIFI**

Thousands of TV channels & movies available to watch any time you want. Watch all the most popular TV series and movies as well as live sports & documentaries. Available worldwide for most devices. All available for less than 10 pesos a day, with help setting up and local assistance. Works with most devices as well as smart TV's.

Whatsapp me for more details

**Colin 809-449-1819**

"overnight oats" "gig economy" "tiny home" you are a peasant who eats gruel

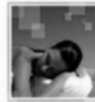

**Ton Plokkaar**

The best massage in town!

**PROFESSIONAL MASSAGE**

- Therapeutic Massage
- Sport Massage
- Deep Tissue Massage Trigger
- Point Massage Lymph
- Massage/Drainage
- Relaxation Massage
- Laser Therapy
- Pain Management

Home And Hotel Visits

Tel: **829 549 9516**

Email: [plokkie@hotmail.com](mailto:plokkie@hotmail.com)



WhatsApp

*Ton Plokkaar is certified and member of VOMAS: No. 12721007*



People often say they hope their deceased pet dog is chasing squirrels in doggy heaven... what did all of those squirrels do to deserve an afterlife of torment?

siketreeker

Dog heaven is also squirrel h... I it's a very efficient system.

ubercharge

i can't stop ... laughing at the thought of squirrels sinning so much in the mortal plane that they have to be sent to squirrel h... I to atone

sapphireswimming

They know that the bird feeder isn't meant for them

# THE RAINY DAY PAGE

## SOLUTIONS ON PAGE 9

### SUDOKU PUZZLES

Fill in the missing numbers so every row, column and quadrant contains the number 1 through 9.

### EASY

3		2	9					4
	4					1		5
	7	8	3	4				
	6							
				7			9	
		3					5	8
	1	7	2				6	
				5				1
	2	9	7					

### MEDIUM

		9		6	2	4		
2								
3	5		8			1		
		1		7		3	2	
5			9					
					8		9	5
	7					2		
9					6		5	8
6	4	8						1

## FAMILY TIES

Find and circle all of the words that are hidden in the grid. The remaining letters spell a hidden message

W E H P E N R E L A T I V E S F  
 S T E L P I R T R E H T A F R S  
 S B R O T H E R S A M R W E B R  
 K C M E S D E M P P E O L I O E  
 L I L O H L E A O T O A M D N T  
 O G N A C T R W S T T U E T D S  
 F E E N N E O I Y I H S S N D I  
 F G U N N C S R O L C E E E A S  
 S A N T E F E N B E W R R R U H  
 P I S I L O S S N F D E E A G U  
 R R W A L N L D T L L C N P H S  
 I R H I I B A O I O I A I P T B  
 N A L S F N I H G E R U H E E A  
 G M U D T E C S N Y Y N R T R N  
 E O A S Y N E G O R P T U S N D  
 C D I T N E R A P D N A R G O N

- |             |              |           |            |
|-------------|--------------|-----------|------------|
| ANCESTOR    | FATHER       | MOTHER    | SISTERS    |
| AUNT        | FOLKS        | NEICE     | SON        |
| BOND        | GENEALOGY    | NEPHEW    | SPOUSE     |
| BROTHERS    | GRANDPARENT  | NEWLYWED  | STEPPARENT |
| CHILDREN    | HALF BROTHER | OFFSPRING | TRIPLETS   |
| CLAN        | HALF SISTER  | PARENTS   | TWINS      |
| COUSINS     | HUSBAND      | PROGENY   | UNCLE      |
| DAD         | KIN          | RELATIONS | WIFE       |
| DAUGHTER    | MARRIAGE     | RELATIVES |            |
| DESCENDANTS | MOM          | SIBLING   |            |

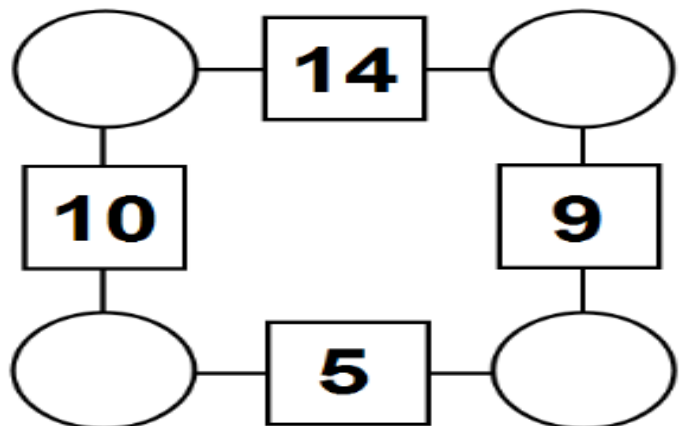

The aim of an arithmagon is to work out which numbers go in the empty circles. The numbers in the square boxes are made by adding together the numbers in the circles either side. For example, if the number in the square box was 10 you could try 6 and 4, but the numbers must also add up on the other edges, making this more difficult than it first appears.

<b>USEFUL NUMBERS</b>	
Police Office	809-320-8510
Police Car	809-320-8840
APC Office	809-970-7877
APC Gate Security	809-970-7015
Codetel	809-220-1111
Edenorte - emergency	809-261-1844
Edenorte - office	809-586-9823
Costambar Taxi Stand	809-970-7318
<b>CONSULATES</b>	
Canada	809-586-5761
Britain	809-586-4244
U.S.A.	809-586-4204
German	809-542-8949
Italian	809-320-7601
<b>HOSPITALS/CLINICS</b>	
Clinica Bournigal	809-586-2342
Clinica Brugal	809-586-2519
Los Tropicos Pharmacy	809-970-7607

# TRAVEL INFO

## OVERSTAY FEES

Calculation for Stay Payment

Duration of stay	Current rate
30 días a 90 días	RD\$ 3,500.00
3 a 9 meses	RD\$ 5,600.00
9 a 12 meses	RD\$ 7,000.00
12 a 18 meses	RD\$9,100.00
18 a 24 meses	RD\$ 11,200.00
24 a 30 meses	RD\$ 13,300.00
30 a 36 meses	RD\$ 15,400.00
36 a 48 meses	RD\$ 22,400.00
48 a 60 meses	RD\$ 28,000.00
6 años	RD\$ 42,000.00
7 años	RD\$ 56,000.00
8 años	RD\$ 70,000.00
9 años	RD\$ 84,000.00
10 años	RD\$ 98,000.00

Note: From ten (10) years, each year or fraction, will increase RD \$ 7,000.00. This payment is not an extension that authorizes the foreigner to remain in the country

**Digital Entry & Departure Forms**  
<https://eticket.migracion.gob.do/>

# CLASSIFIED ADS

**FOR SALE**  
 Glass top dining table 44" diameter with 4 chairs - US\$200  
 Contact Douglas 829 343 1221

[www.costambarmonthly.com](http://www.costambarmonthly.com)  
[costambarmonthly@gmail.com](mailto:costambarmonthly@gmail.com)

### COSTAMBAR MONTHLY

RATE CARD  
NOVEMBER 2015

SIZE	APPROX. SIZE	PRICE/MONTH
FULL PAGE – BACK	8"X10"	RD\$4200
FULL PAGE – INTERIOR	8"X10"	RD\$3700
1/2 PAGE	8"X5" OR 4"X10"	RD\$2100
1/4 PAGE	4"X5"	RD\$1150
1/8 PAGE	4"X2.5"	RD\$650
BUSINESS CARD AD	4"X2"	RD\$520
CUSTOM SIZE/SHAPE ADS		Contact Us for a Quote

CONTACT US AT:  
 WEBSITE [www.costambarmonthly.com](http://www.costambarmonthly.com)  
 EMAIL [costambarmonthly@gmail.com](mailto:costambarmonthly@gmail.com)  
 PHONE 809-970-7507



**Jenny's Supermarket**  
 OPEN DAILY (INCLUDING HOLIDAYS)  
 Mon-Sat 8am-10pm Sundays 8am-8pm  
 Everything you need from snacks to supper!  
 Delivery Service Available!  
 Calle Principal, Costambar (just inside the gate)  
 809-970-3028

[www.costambarmonthly.com](http://www.costambarmonthly.com)

**TOM CIGARS**  
 QUALITY CIGARS AT FAIR PRICES  
 829-925-2989/829-721-9435  
 Thomasaikins644@gmail.com  
 16 de agosto, esq. 12 de Julio, Puerto Plata

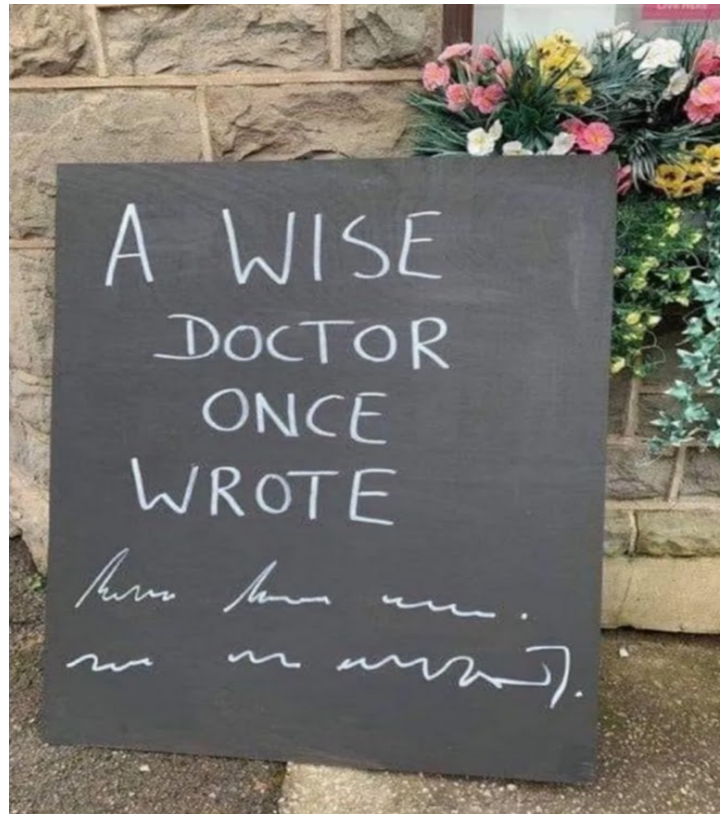

Friend: I'm worried about you  
 Me: \*dunks oreo into whiskey\* why

**SOLUTIONS TO PUZZLES ON PAGE 7**

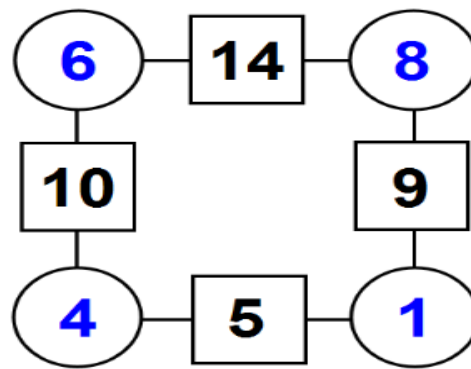
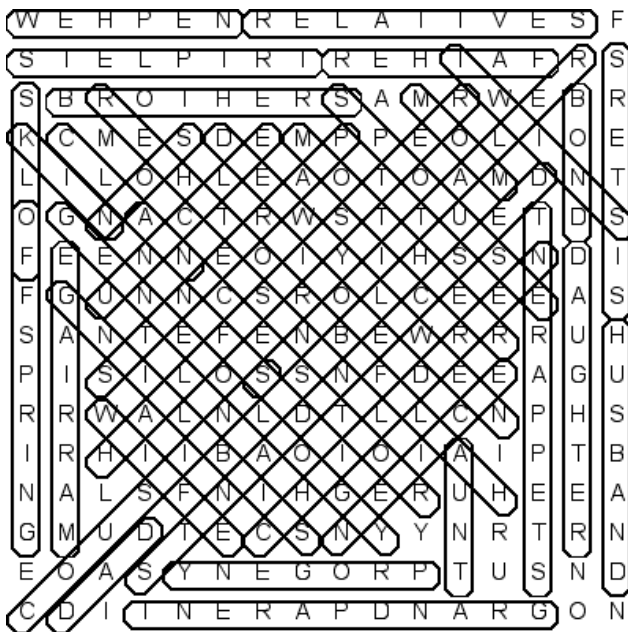

**EASY**

**MEDIUM**

3	5	2	9	1	6	7	8	4
9	4	6	8	2	7	1	3	5
1	7	8	3	4	5	9	2	6
2	6	5	4	9	8	3	1	7
4	8	1	5	7	3	6	9	2
7	9	3	1	6	2	4	5	8
5	1	7	2	3	4	8	6	9
8	3	4	6	5	9	2	7	1
6	2	9	7	8	1	5	4	3

7	1	9	5	6	2	4	8	3
2	8	4	7	3	1	5	6	9
3	5	6	8	9	4	1	7	2
8	9	1	6	7	5	3	2	4
5	6	2	9	4	3	8	1	7
4	3	7	1	2	8	6	9	5
1	7	5	3	8	9	2	4	6
9	2	3	4	1	6	7	5	8
6	4	8	2	5	7	9	3	1

**HIDDEN MESSAGE FAMILY REUNION**



## FOR RENT

### STUDIO APT

AVAILABLE STARTING APRIL THRU DECEMBER.  
3RD FLOOR, CATHEDRAL CEILINGS, FURNISHED  
AIR, WIFI, PRIVATE ENTRANCE  
OCEAN VIEW - 2 BLOCKS FROM THE BEACH  
\$400/ MONTH + ELECTRIC, 1ST MONTH + SECURITY DEPOSIT

### 2 BEDROOM 2 BATH

3RD FLOOR, CATHEDRAL CEILINGS, FURNISHED  
ROOF TOP GARDEN, OCEAN VIEWS / MOUNTAIN VIEWS  
AIR, WIFI, 2 BLOCKS FROM BEACH  
\$800 MONTH + ELECTRIC, 1ST MONTH + SECURITY DEPOSIT

WhatsApp 809-266-7122 / mjpd345@gmail.com

I don't know what this cat is going through, but I can relate.



## SOLAR PANELS FOR YOUR HOME

The Way To Go  
550 watt panels  
Now available in Costambar

You don't need to spend a lot to make your life in paradise more pleasant during power cuts

Whatsapp Colin  
809-449-1819

CALLER: Is this Pizza Hut?

GOOGLE: No sir, it's Google Pizza.

CALLER: I must have dialed a wrong number, sorry.

GOOGLE: No sir, Google bought Pizza Hut last month.

CALLER: OK. I would like to order a pizza.

GOOGLE: Do you want your usual, sir?

CALLER: My usual? You know me?

GOOGLE: According to our caller ID data sheet, the last 12 times you called you ordered an extra-large pizza with three cheeses, sausage, pepperoni, mushrooms and meatballs on a thick crust.

CALLER: Super! That's what I'll have.

GOOGLE: May I suggest that this time you order a pizza with ricotta, arugula, sun-dried tomatoes and olives on a whole wheat gluten-free thin crust?

CALLER: What? I don't want a vegetarian pizza!

GOOGLE: Your cholesterol is not good, sir.

CALLER: How the hell do you know that?

GOOGLE: Well, we cross-referenced your home phone number with your medical records. We have the result of your blood tests for the last 7 years.

CALLER: Okay, but I do not want your rotten vegetarian pizza! I already take medication for my cholesterol.

GOOGLE: Excuse me sir, but you have not taken your medication regularly. According to our database, you purchased only a box of 30 cholesterol tablets once at Lloyds Pharmacy, 4 months ago.

CALLER: I bought more from another Pharmacy.

GOOGLE: That doesn't show on your credit card statement.

CALLER: I paid in cash.

GOOGLE: But you did not withdraw enough cash according to your bank statement.

CALLER: I have other sources of cash.

GOOGLE: That doesn't show on your latest tax returns, unless you bought them using an undeclared income source, which is against the law!

CALLER: WHAT THE HELL!

GOOGLE: I'm sorry sir, we use such information only with the sole intention of helping you.

CALLER: Enough already! I'm sick to death of Google, Facebook, Twitter, WhatsApp and all the others. I'm going to an island without the internet, TV, where there is no phone service and no one to watch me or spy on me.

GOOGLE: I understand sir, but you need to renew your passport first. It expired 6 weeks ago... Welcome to the future

# BOATING NEEDS

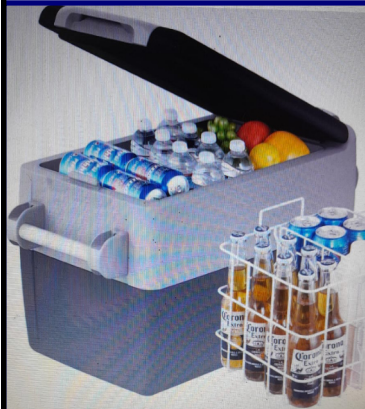

**BOAT/CAR  
FRIDGE/  
FREEZER**  
- 12/24V DC  
- 110V AC  
ADAPTER  
- LARGE  
CAPACITY

**DUAL COMPARTMENT  
ANTI-SHAKE DESIGN  
CAN TILT 40 DEGREES  
BUILT IN LED LIGHT  
LOW ENERGY CONSUMPTION  
ENERGY SAVING MODE  
LOW BATTERY PROTECTION  
AUTO-STOP WHEN LOW  
BATTERY**

**ONLY 2 LEFT!  
US\$320**

**NOW IN STOCK**



Solar lights  
ideal for  
mounting on  
Outboard engine,  
boat decks etc  
"Be seen!".

**FOR MORE DETAILS  
AND TO PLACE AN  
ORDER**

## BOATER'S SPECIAL

*Health Insurance Plans  
Available for terms as short as 3 months  
Available up to the age of 65*

**Call/WhatsApp Alison 829-805-5196**

**Or Colin 809-449-1819 or**

**Email [drcigarman@yahoo.com](mailto:drcigarman@yahoo.com)**

**For more information**

## SOLAR PANELS IN STOCK

## BATTERIES

- Lithium
- Deep cycle AGM 12v
- Trojan 6v red and black
- Starter batteries



**6v 210ah AGM**

**RD\$11,750**

**Delivered To Luperon & Ocean World**

**Call/Whatsapp**

**Alison 829-805-5196**

**Colin 809-449-1819**

**Email [drcigarman@yahoo.com](mailto:drcigarman@yahoo.com)**



# **Sea Horse Condos Ocean View Condominiums**

**ONCE YOU'VE SEEN THE REST  
STAY AT THE BEST  
BEST CONDOS IN THE BEST  
COMPLEX IN COSTAMBAR FOR SALE  
FOR SALE 1 TO 3 BEDROOM**

- Condo #1 3 Bdrm mtn view \$139,000**
- Condo #2 2 Bdrm ocean view \$149,000**
- Condo #4 3 Bdrm ocean view \$159,000**
- Condo #6 3 Bdrm ocean view \$169,000**
- Condo #8 1 Bedroom \$109,000**
- Condo #9 2 Bedroom \$129,000**

**RENTALS COMING APRIL 1st  
\$500-\$1000 Studio to 3 bedroom**

**POOL-JACUZZI-GYM-BILLIARDS  
POWER PLANT-24HR SECURITY  
OFF STREET PARKING  
OCEAN VIEWS AND BREEZES**

**[jackflor@aol.com](mailto:jackflor@aol.com)**

**Call 809-844-0684/Whatsapp 218-348 -3050**